

MAIN CHARACTERISTICS

I_D	13A
V_{DS}	800V
$R_{DS(on)-typ}$ (@VGS=18V Tc=25°C)	268mΩ

Features

- High Speed Switching with Low Capacitances
- High Blocking Voltage with Low RDS(on)
- Easy to paralle
- Simple to drive
- RoHS Compliant

Benefits

- Increased Power Density
- Faster Operating Freequency
- Reduction of Heat Sink Requirements
- Higher Efficiency
- Reduced EMI

Application

- Power Factor Correction Modules
- Switch Mode Power Supplies
- DC-AC Inverters
- High Voltage DC/DC Converters

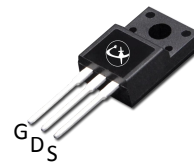
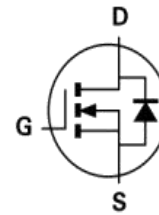

TO-220F

Product specification classification

Part Number	Package	Mode Name	Pack
LSC280M65F	TO-220F	LSC280M65F	Tube

Maximum Ratings at Tc=25°C unless otherwise specified

Parameter	Symbol	Value	Unit
Drain-Source Voltage	V_{DS}	800	V
Gate-Source Voltage	V_{GS}	-8/+22	V
Recommended Operation Value	V_{GSop}	-4/+18	V
Continue Drain Current TC=25°C	I_D	13	A
Continue Drain Current TC=100°C		9.5	A
Pulsed Drain Current (Note1)	I_{DM}	22	A
Power Dissipation	P_D	57	W
Operating Temperature Range	T_J	-40 to +175	°C
Storage Temperature Range	T_{STG}	-40 to +175	°C
Thermal Resistance, Junction to Case	$R_{\theta JC}$	3.76	°C/W
Thermal Resistance, Junction to Ambient	$R_{\theta JA}$	40	°C/W

Note1:Pulse test: 300 μ s pulse width, 2 % duty cycle

Electrical Characteristics at Tc=25°C unless otherwise specified

Parameter	Test Condition	Symbol	Min	Typ	Max	Unit
Drain-Source Breakdown Voltage	$V_{GS} = 0 V, I_D = 100\mu A$	BV_{DSS}	800	-	-	V
Drain-Source Leakage Current	$V_{DS} = 800 V, V_{GS} = 0 V$	I_{DSS}	-	1	-	μA
Gate Leakage Current	$V_{GS} = 18 V, V_{DS} = 0 V$	I_{GSS}	-	-	250	nA
Gate-Source Threshold Voltage	$V_{DS} = V_{GS}, I_D = 1.33 mA$	$V_{GS(th)}$	2	3.1	4	V
Drain-Source On-State Resistance	$V_{GS} = 15 V, I_D = 4.5 A$	$R_{DS(on)}$	-	370	500	m Ω
	$V_{GS} = 15 V, I_D = 4.5 A, T_J = 175^\circ C$		-	340	-	
	$V_{GS} = 18 V, I_D = 4.5 A$		-	268	357	
	$V_{GS} = 18 V, I_D = 4.5 A, T_J = 175^\circ C$		-	298	-	
Input Capacitance	$V_{GS} = 0 V, V_{DS} = 600 V, f = 1MHz$	C_{iss}	-	203	-	pF
Output Capacitance		C_{oss}	-	26	-	pF
Reverse Transfer Capacitance		C_{rss}	-	3.5	-	pF
Internal Gate Resistance	$f=1MHz$	$RG(int)$	-	3.6	-	Ω
Total Gate Charge(Note2)	$I_D = 4.5 A, V_{DD} = 400 V, V_{GS} = -4/18 V$	Q_G	-	11.2	-	nC
Gate to Source Charge(Note2)		Q_{GS}	-	2	-	nC
Gate to Drain Charge(Note2)		Q_{GD}	-	5.2	-	nC
Turn-on Delay Time(Note2)	$V_{DS} = 400 V, I_D = 4.5 A, V_{GS} = -4/18 V, RG = 2.5 \Omega$	$t_{d(ON)}$	-	3	-	ns
Rise Time(Note2)		t_r	-	8	-	ns
Turn-Off Delay Time(Note2)		$t_{d(OFF)}$	-	6	-	ns
Fall Time(Note2)		t_f	-	11	-	ns
Turn-On Energy		E_{on}	-	21	-	μJ
Turn-Off Energy		E_{off}	-	5	-	μJ

Source-Drain Diode Characteristics at Ta=25°C unless otherwise specified

Parameter	Test Condition	Symbol	Min.	Typ.	Max.	Unit
Maximun Body-Diode Continuous Current	VGS=-4V Tc=25°C	I _S	-	13	-	A
	VGS=-4V Tc=100°C		-	6.5	-	A
Maximun Body-Diode Pulsed Current(Note2)		I _{SM}	-	-	22	A
Drain-Source Diode Forward Voltage	VGS=-4V, ISD=2.5A Tj=25°C	V _{SD}	-	4	-	V
	VGS=-4V, ISD=2.5A Tj=175°C		-	3.6	-	V
	VGS=-4V, ISD=4.5A Tj=25°C	V _{SD}	-	4.5	-	V
	VGS=-4V, ISD=4.5A Tj=175°C		-	4	-	V
Reverse Recovery Time(Note2)	VGS=-4V, ISD=4.5A,	trr	-	10	-	ns
Reverse Recovery Charge(Note2)	VR=400V, di/dt=1000A/μs	Qrr	-	56	-	nC
Peak Reverse Recovery Current		Irrm	-	4	-	A

Note2:Pulse test: 300 μs pulse width, 2 % duty cycle

RATINGS AND CHARACTERISTIC CURVES

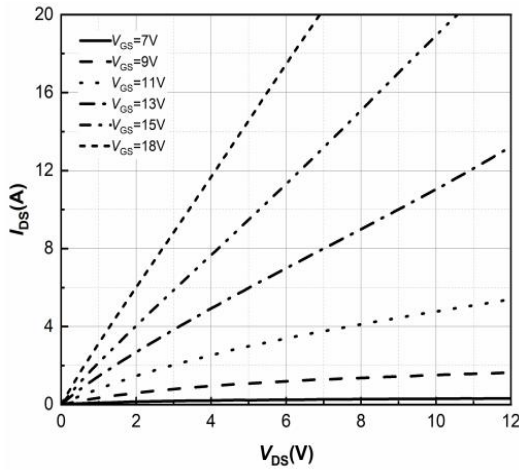

Figure 1. Output Characteristics
 $T_j = -40^\circ\text{C}$

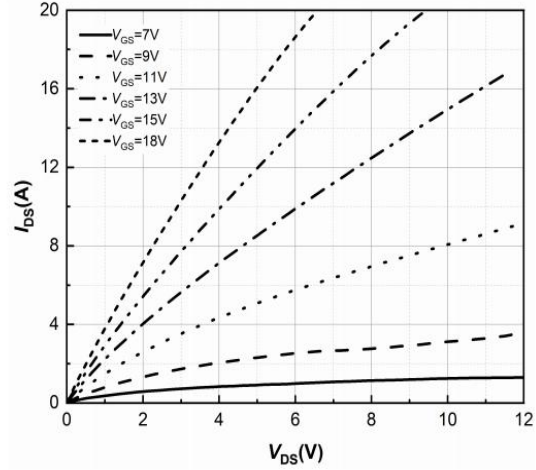

Figure 2. Output Characteristics

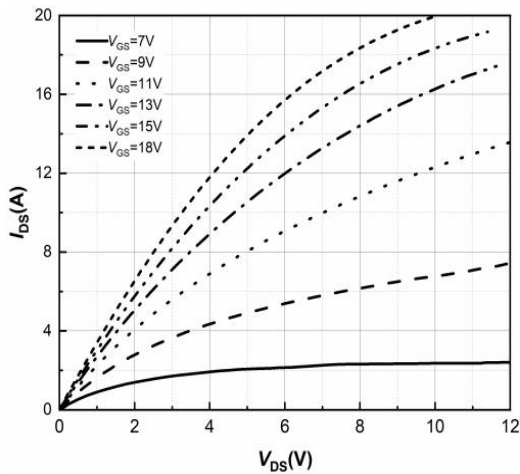

Figure 3. Output Characteristics
 $T_j = 175^\circ\text{C}$

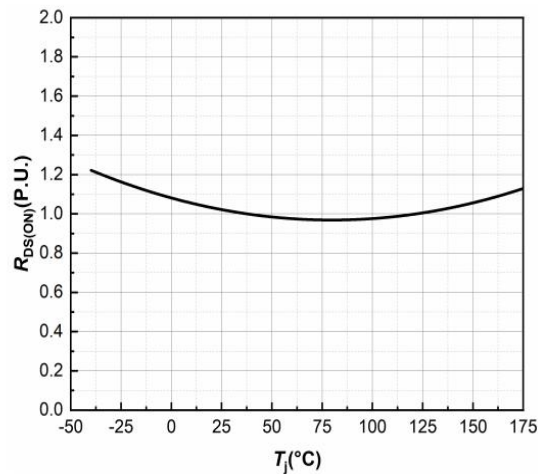

Figure 4. Normalized On-Resistance vs. Temperature

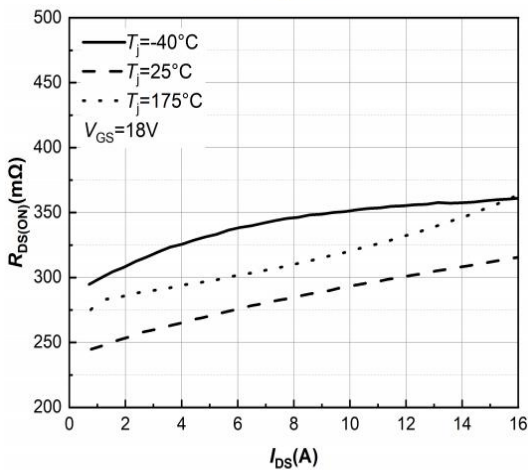

Figure 5. On-Resistance vs. Drain Current For Various Temperatures

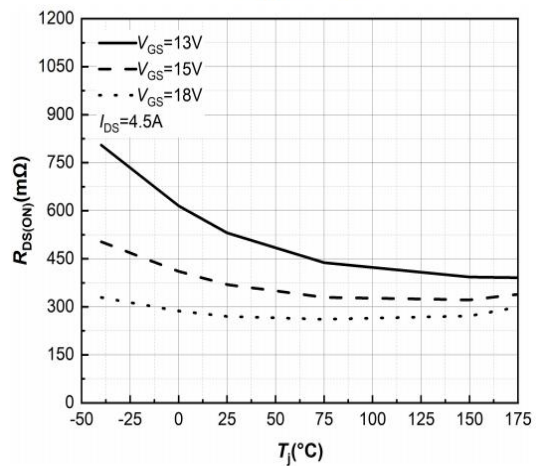

Figure 6. On-Resistance vs. Temperature For Various Gate Voltage

RATINGS AND CHARACTERISTIC CURVES

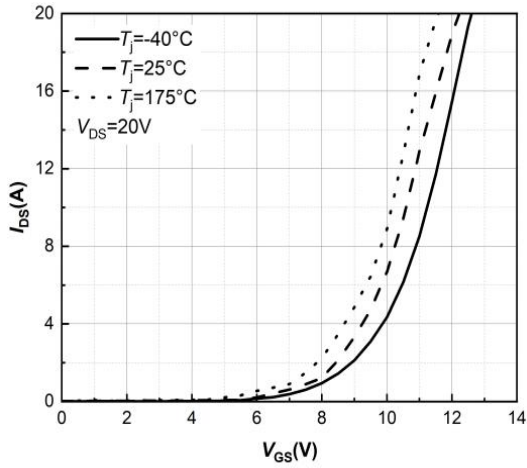

Figure 7. Transfer Characteristic for Various Junction Temperatures

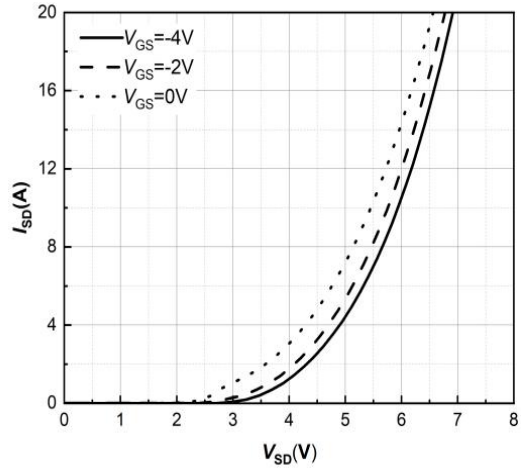

Figure 8. Body Diode Characteristic $T_j = -40^\circ\text{C}$

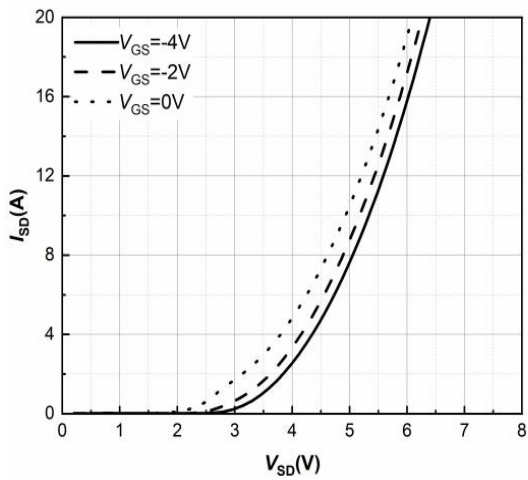

Figure 9. Body Diode Characteristic $T_j = 25^\circ\text{C}$

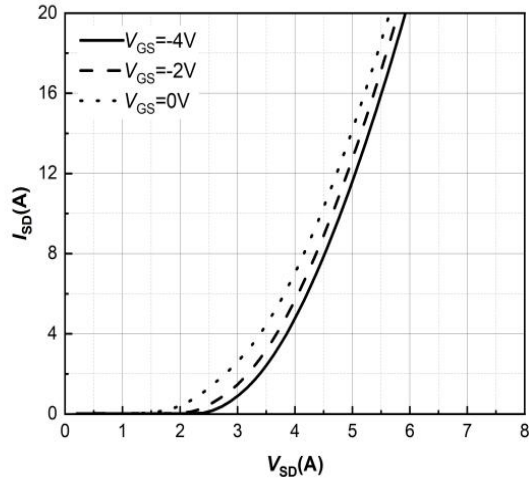

Figure 10. Body Diode Characteristic $T_j = 175^\circ\text{C}$

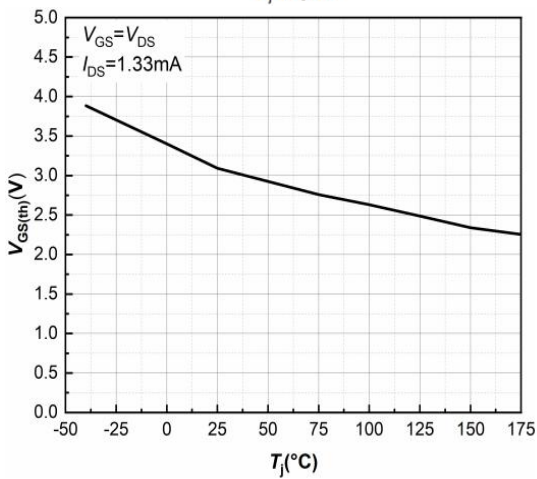

Figure 11. Threshold Voltage vs. Temperature

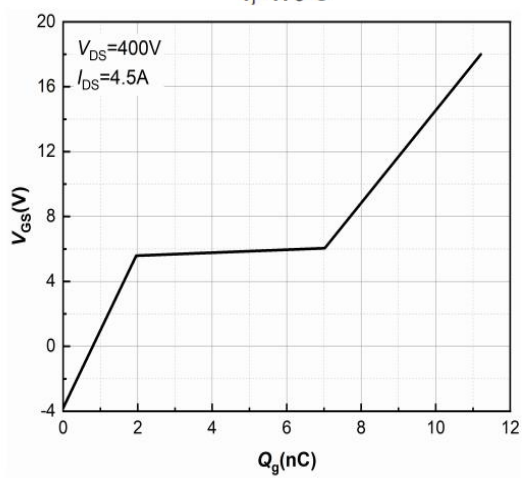

Figure 12. Gate Charge Characteristics

RATINGS AND CHARACTERISTIC CURVES

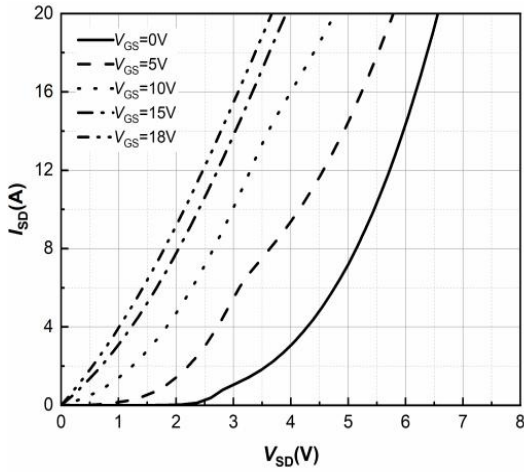

Figure 13. 3rd Quadrant Characteristic
 $T_j = -40^\circ\text{C}$

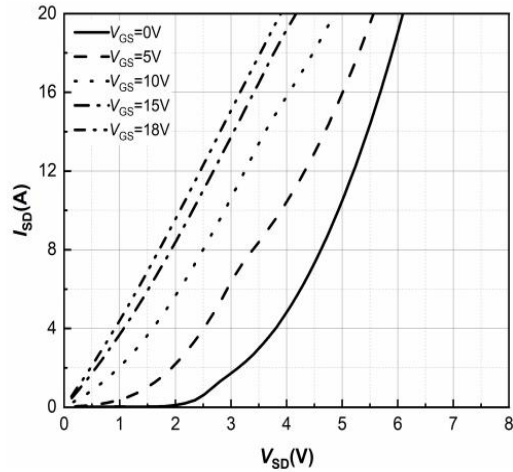

Figure 14. 3rd Quadrant Characteristic
 $T_j = 25^\circ\text{C}$

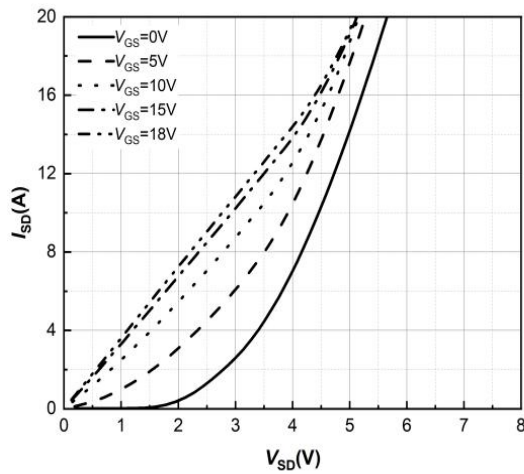

Figure 15. 3rd Quadrant Characteristic
 $T_j = 175^\circ\text{C}$

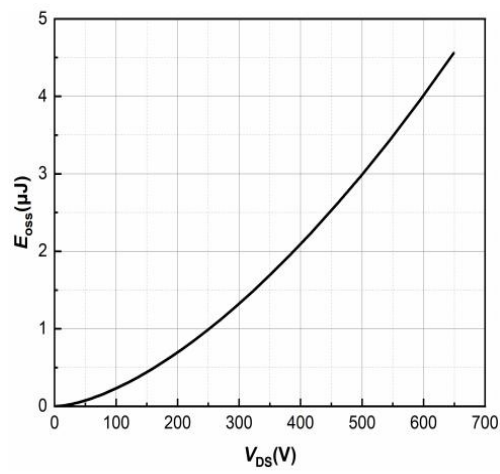

Figure 16. Output Capacitor Stored Energy

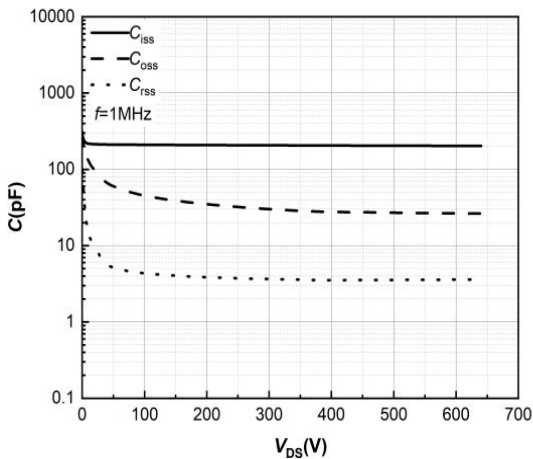

Figure 17. Capacitances vs. Drain-Source

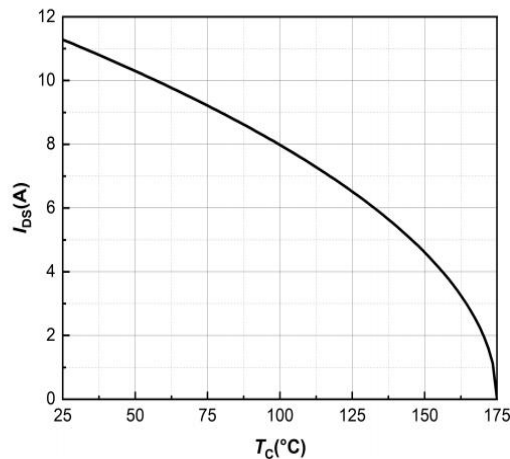

Figure 18. Continuous Drain Current Derating vs. Case Temperature

RATINGS AND CHARACTERISTIC CURVES

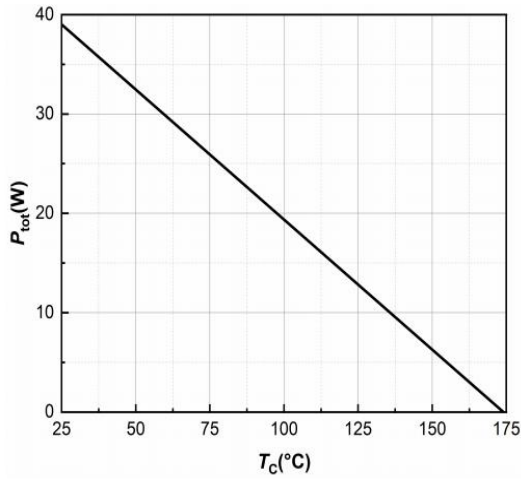

Figure 19. Maximum Power Dissipation Derating vs. Case Temperature

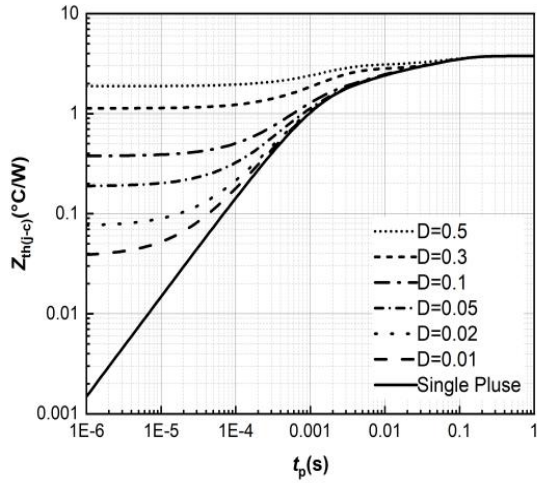

Figure 20. Transient Thermal Impedance

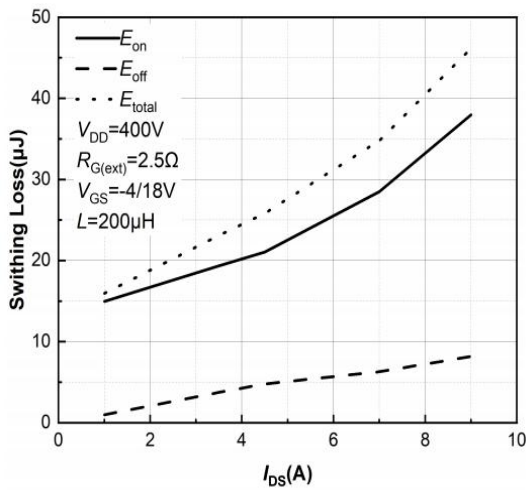

Figure 21. Clamped Inductive Switching Energy vs. Drain Current

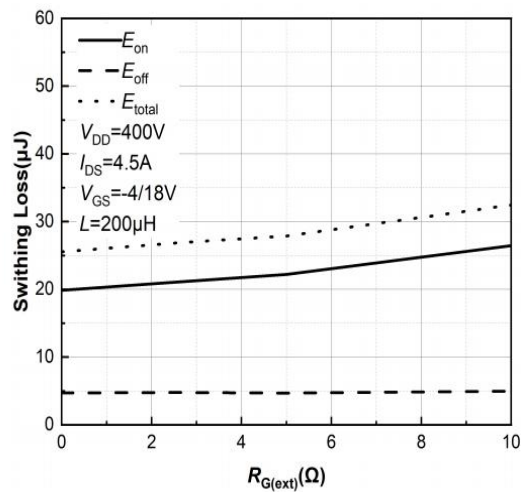

Figure 22. Clamped Inductive Switching Energy vs. R_G

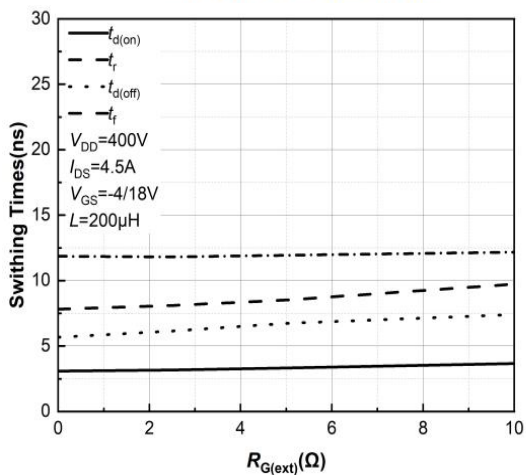

Figure 23. Switching Times vs. R_G

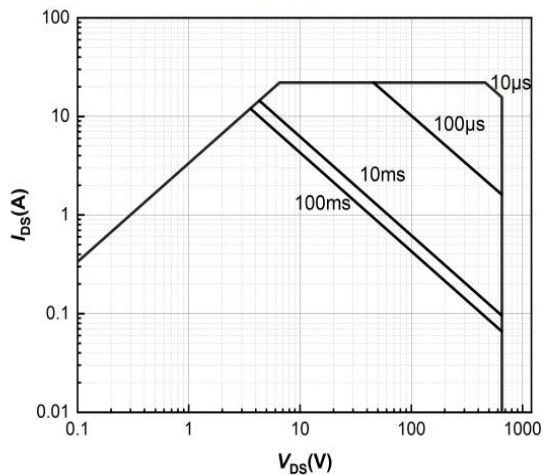
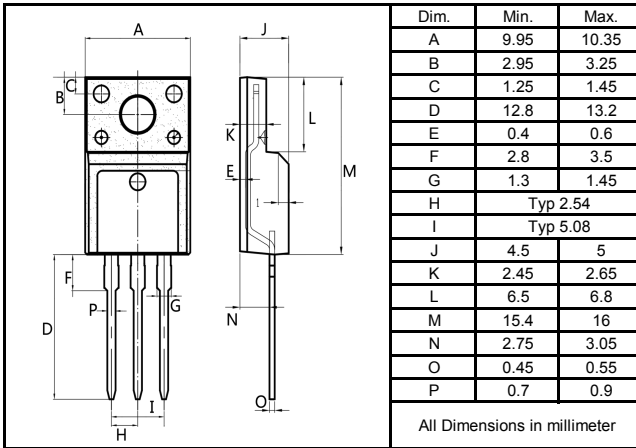

Figure 24. Safe Operating Area

Package Outline Dimensions millimeters



T0-220F

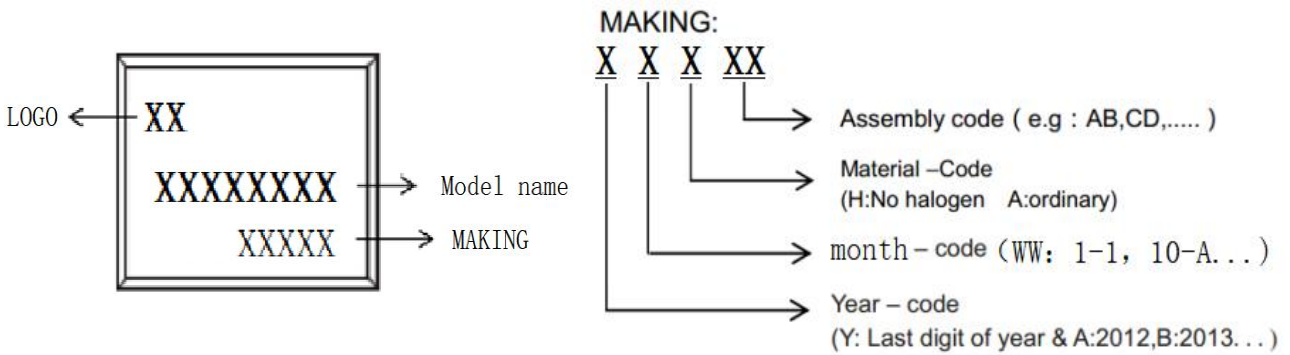

Marking on the body

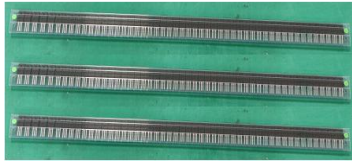
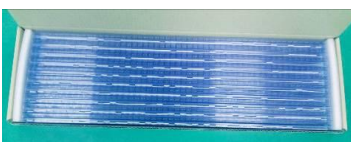

packing instruction

PKG	Minimal Package	Mini Box	Box
TO-220F			
	50pcs/pdpe	1000pcs/box	5000pcs/box

Notice

All product, product specifications and data are subject to change without notice to improve. The right to explain is owned by LINGXUN electronics company.

Confirm that operation temperature is within the specified range described in the product specification. Avoid applying power exceeding normal rated

power; exceeding the power rating under steady-state loading condition may negatively affect product performance and reliability.

LINGXUN electronics shall not be in any way responsible or liable for failure induced under deviant condition from what is defined in this document.

<http://www.lxmicro.com>

Revision History

Rev	Changes	Date
2.0	First version	2026/4/2