

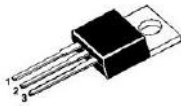

LOW VF SCHOTTKY RECTIFIER

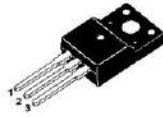

TO-220AB/CT



TO-220F/FCT

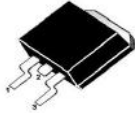

TO-263/DC

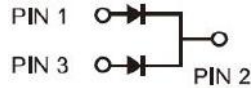

FEATURES

- Low forward voltage
- High current capability
- High forward surge capability
- Low power losses, High efficiency
- Guarding for over voltage protection



APPLICATIONS

Low VF Schottky barrier rectifier are designed for high frequency, miniature switched mode power supplies such as adapters ,lighting and on-board DC/DC conerters

Primary Characteristic

I_o	2*20A
V_{RRM}	45V
I_{FSM}	250A
V_F	0.43V
T_{jmax}	150°C

MECHANICAL DATA

- **Case:** Molded plastic
- **Polarity:** As marked
- **Mounting Position:** Any
- **Molded Plastic:** UL Flammability Classification Rating 94V-0
- Lead free in compliance with EU RoHS 2011/65/EU directive
- Solder bath temperature 275°C maximum,10s per JESD 22-B106

Maximum Ratings (Per Leg) at Ta=25°C unless otherwise specified

Characteristics	Symbol	Value	Unit
Maximum Repetitive Peak Reverse Voltage	V_{RRM}	45	V
Working Peak Reverse Voltage	V_{RWM}	45	V
Maximum DC Blocking Voltage	V_{DC}	45	V
Maximum Average Forward Rectified Current	Per Leg	IO	20
		Total	40
Peak Forward Surge Current,8.3 ms Single Half Sine-wave Superimposed on Rated Load (JEDEC method)	I_{FSM}	250	A
Operating Temperature Range	T_J	-50 to +150	°C
Storage Temperature Range	T_{STG}	-50 to +150	°C
Typical Thermal Resistance (Note1) TO-220AB,TO-263	$R_{\theta JC}$	2	°C/W
		TO-220F	

Note1: Thermal resistance from Junction to case per leg mounted on heatsink.

Electrical Characteristics (Per Leg) unless otherwise specified

Characteristics	Symbol	Value		Unit	
		Typ.	Max.		
Forward Voltage Drop(Note2) at $I_F=5A$	V_F	TA=25°C	0.37	-	
		TA=125°C	0.27	-	
		at $I_F=10A$	TA=25°C	0.41	-
			TA=125°C	0.33	-
		at $I_F=20A$	TA=25°C	0.47	0.55
			TA=125°C	0.43	-
Maximum Reverse Current at $V_R=45V$	I_R	TA=25°C	90	200	
		TA=125°C	22	-	

Note2:Pulse test: 300 μs pulse width, 1 % duty cycle



RATINGS AND CHARACTERISTIC CURVES

FIG.1 MAXIMUM FORWARD CURRENT DERATING CURVE

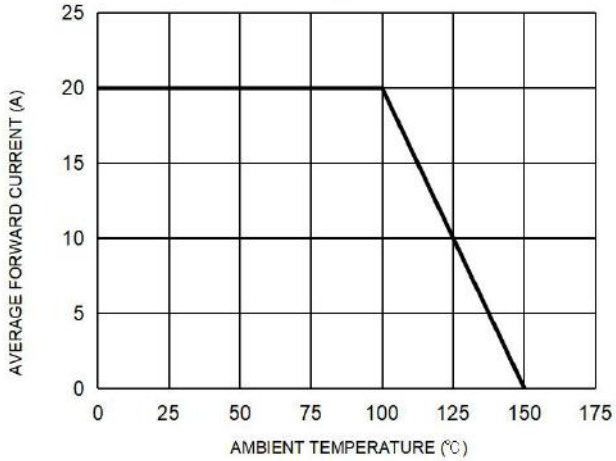

FIG. 2 MAXIMUM NON-REPETITIVE FORWARD SURGE CURRENT PER LEG

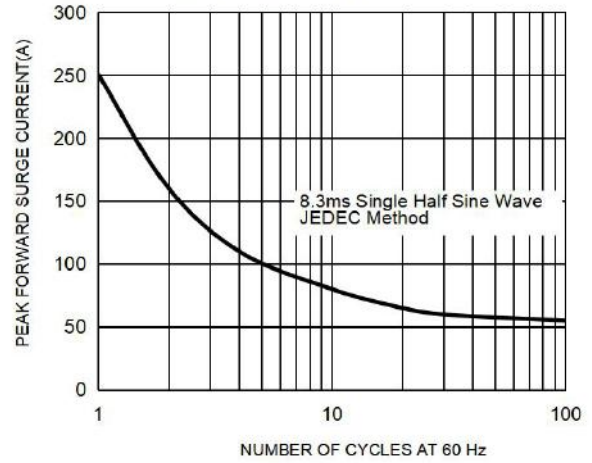

FIG. 3 TYPICAL FORWARD CHARACTERISTICS PER LEG

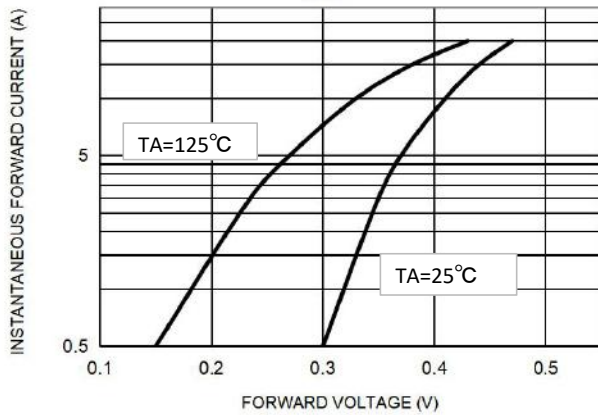
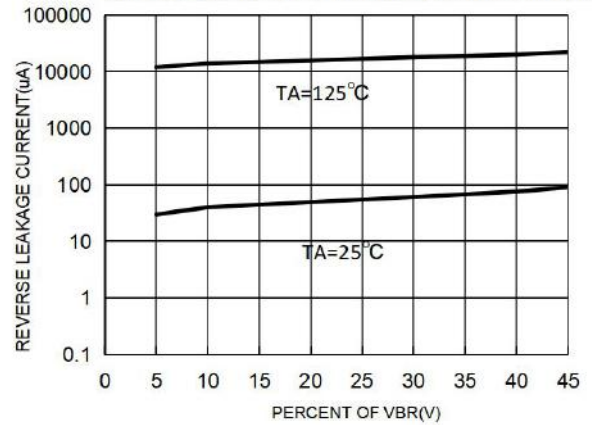

FIG. 4 TYPICAL REVERSE CHARACTERISTICS PER LEG





Package Outline Dimensions millimeters

TO-220AB

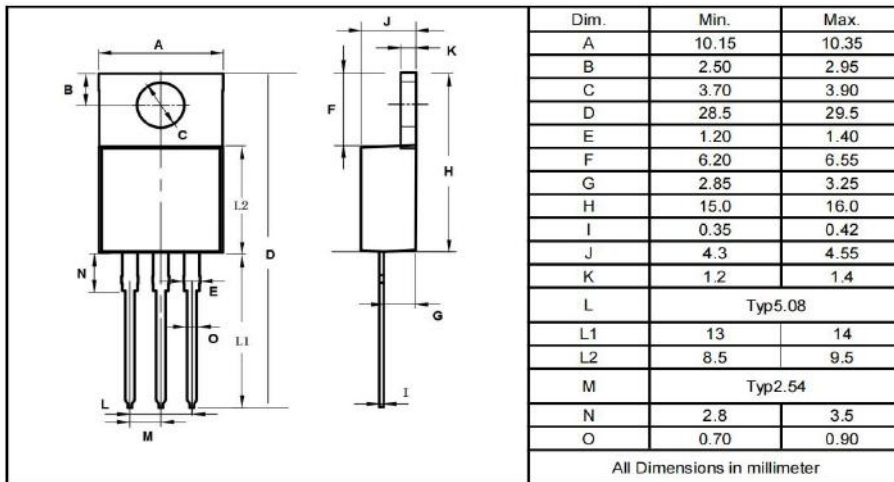

TO-220F

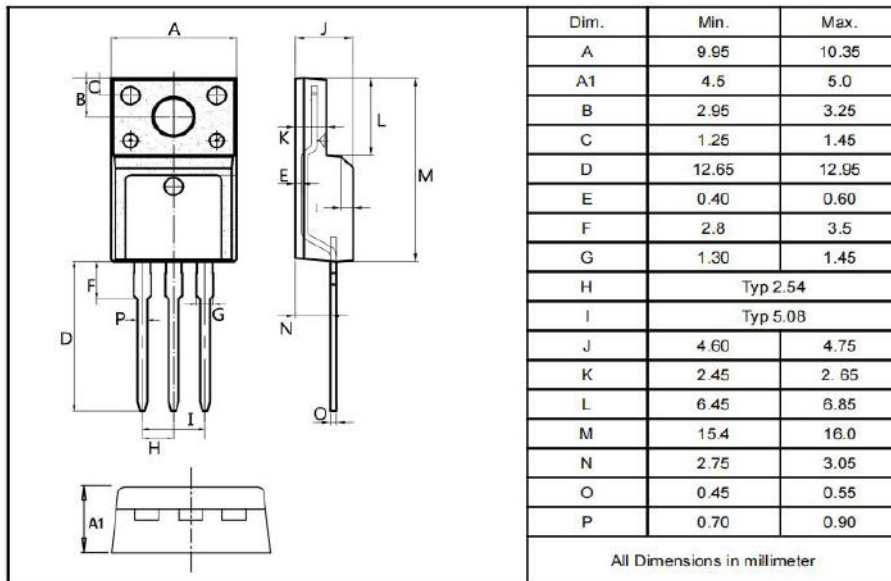

TO-263

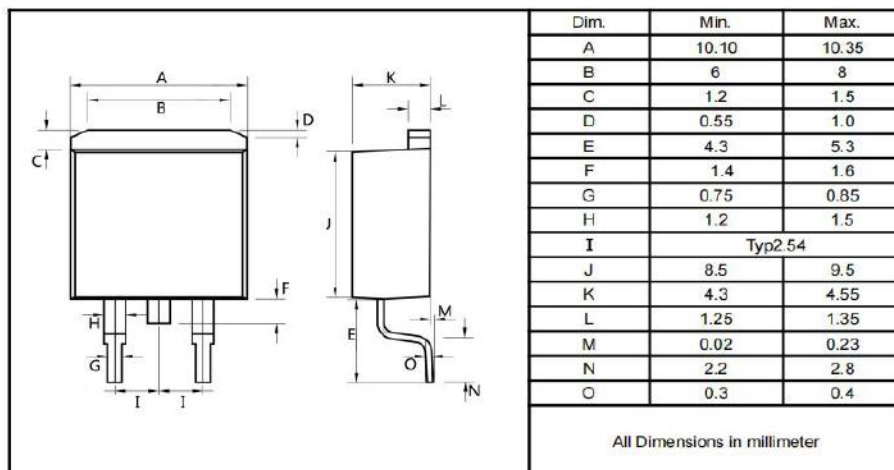



Marking on the body

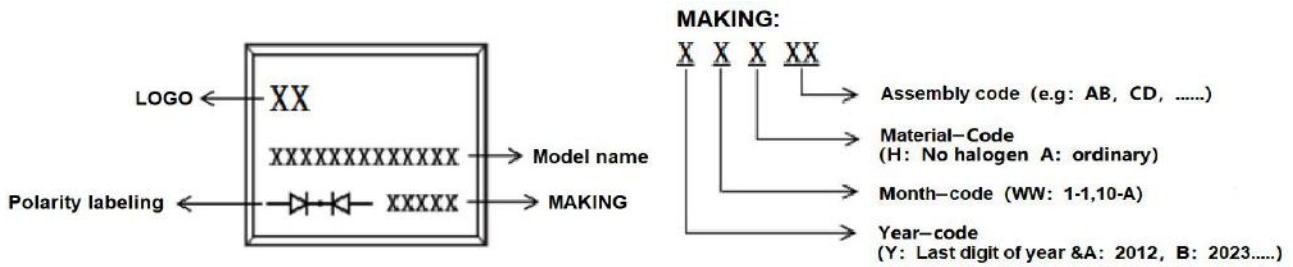

Ordering information

Part Number	Package	Unit Weight	Base Quantity	Delivery mode
SBT40L45CT	TO-220AB	0.07oz(1.96g)	50 pcs / tube	1000pcs/box 5000pcs/carton
SBT40L45FCT	TO-220F	0.06oz(1.74g)	50 pcs / tube	1000pcs/box 5000pcs/carton
SBT40L45DC	TO-263	0.04oz(1.16g)	50 pcs / tube	1000pcs/box 5000pcs/carton
SBT40L45DC-R	TO-263	0.04oz(1.16g)	800 pcs / reel	1600pcs/box 8000pcs/carton

Note: For Halogen Free molding compound, add "H" suffix to part number above.

packing instruction

PKG	最小包装	内盒	外箱
TO-220AB TO-220F TO-263 TO-262			
	50pcs/管	1000pcs/盒	5000pcs/箱
TO-263-R			
	800pcs/盘	1600pcs/盒	8000pcs/箱

Notice

1. All product, product specifications and data are subject to change without notice to improve. The right to explain is owned by LINGXUN electronics company.
2. Confirm that operation temperature is within the specified range described in the product specification. Avoid applying power exceeding normal rated power;
exceeding the power rating under steady-state loading condition may negatively affect product performance and reliability.
3. LINGXUN electronics shall not be in any way responsible or liable for failure induced under deviant condition from what is defined in this document.